

FULL

GENERATOR

FB 44

Diesel Generator

MOTEURS
Baudouin

LEROY-SOMER
FULL
ALTERNATOR

CE    EAC Made in Türkiye

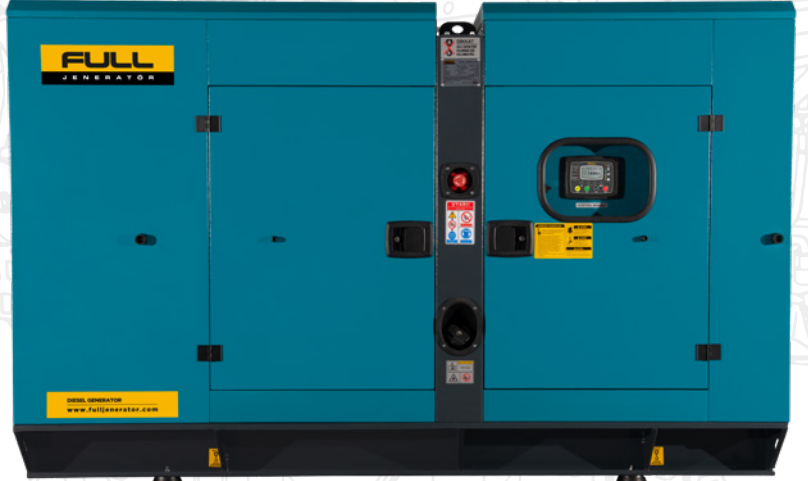

GENERAL SPECIFICATIONS

Stand By Power	kVA	44
	kW	35
Prime Power	kVA	40
	kW	32
Frequency	Hz	50
Cooling System	Water Cooling	

- 1) Standby power: The max power available during a variable electrical power sequence, under the stated operating conditions, for which a generating set is capable of delivering in the event of a utility power outage. Overloading isn't permissible.
- 2) Prime Power: The maximum power which a generating set is capable of delivering continuously whilst supplying a variable electrical load. Average load should be 70%. The generator can be overloaded 10% for 1 hour per 12 hrs.

DIMENSIONS & WEIGHT

WITH CANOPY

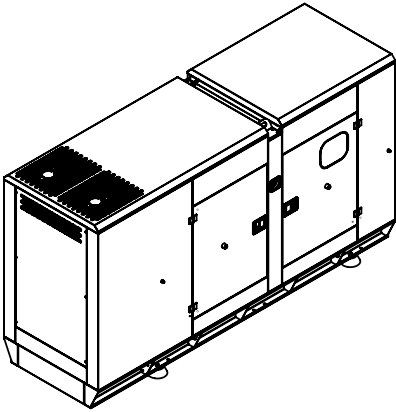

Length L (mm)	Width W (mm)	Height H (mm)	Weight (Kg)	Fuel Tank Capacity
2200	900	1470	950	125

OPEN TYPE

Length L (mm)	Width W (mm)	Height H (mm)	Weight (Kg)	Fuel Tank Capacity
1850	900	1560	770	125

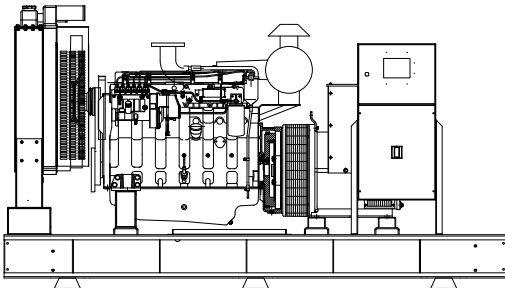

Topçular Endüstriyel Üretim ve Yatırım A.Ş. reserves the right to make changes in model, technical specifications, color, equipment & accessories without prior notice.

☎ 0850 222 86 28

✉ info@fullgenerator.com

▶ full generator

📷 full_generator

📺 /fullgenerator

www.fullgenerator.com

ENGINE

Engine	BAUDOUIIN		
Engine Model			4M06G44-5
Number of Cylinders			4 Inline
Injection System			Direct
Compression Ratio			17.5 : 1
Bore		mm	89
Stroke		mm	92
Displacement		lt	2.3
Air Intake			Turbocharged
Speed (RPM)		rpm	1500
Oil Capacity		lt	9.6
Standby Power		kW / hp	41 / 55
Prime Power		kW / hp	37 / 49.5
Fuel Type			Euro Diesel
Governor System			Electronic
Cooling System			Water Cooling
Coolant Capacity		lt	16
Fuel Consumption (lt / h)	Full Load		9.3
	%75 Load		6.8
	%50 Load		4.6

ALTERNATOR

Frequency		Hz	50
Voltage		V	400
Nb of Phases			3
Voltage Regulation			±1%
Insulation Class			H
Protection Standard			IP23
Power Factor		Cos	0.8

TECHNICAL SPECIFICATIONS

ENGINE

- Baudouin heavy duty diesel engine
- 12V / 24V starter and charge alternator
- Replaceable air, fuel and oil filters
- Mechanical or electronic governor control
- Tropical type radiator
- Flexible fuel hose
- Oil drain valve and extension hose
- Industrial type silencer and steel compensator
- Maintenance-free starter battery
- Water jacket heater
- 1500 rpm engine speed

ALTERNATOR

- IP23 Protection Standard
- H Insulation Class
- 50 Hz Frequency
- 4 pole brushless synchronous type alternator
- Automatic Voltage Regulator (AVR)
- 400/230V AC Output Voltage - 1500 rpm

SOUND PROOF CANOPY AND CHASSIS

- Convenient design for easy lifting and carrying
- High standard sound proof canopy design
- Modular design with easily removable nuts - bolts
- Lockable doors
- Transparent window for watching Control Panel
- Electrostatic powder painted, providing protection against harsh weather conditions
- Emergency STOP button
- Fuel tank inside the chassis
- Anti-vibration wedges (engine - chassis and chassis - ground)

OPTIONAL

- Thermal magnetic CB (for automatic models)
- Super Silent Canopy
- Mobile Generator Sets
- Automatic fuel filling system
- Synchronization panel
- 3 Pole and 4 Pole ATS (Automatic Transfer Switch)
- Fuel Heater, Oil Heater
- External fuel tank and automatic fuel filling system
- Fuel - water separator filter
- Remote monitoring and control system



CONTROL PANEL

D 300

Web based Next Generation Controller



SPECIFICATIONS

- Diesel and gas genset support
- 400Hz operation support
- 400 event logs, full snapshot
- All parameters front panel editable
- 3 level configuration password
- 128x64 graphical LCD display
- Downloadable languages
- Waveform display of V & I
- Harmonic analysis of V & I
- 16Amp MCB & GCB outputs
- 8 configurable digital inputs
- 6 configurable digital outputs
- 3 configurable analog inputs
- Both CANBUS-J1939 & MPU
- 3 configurable service alarms
- Multiple automatic exerciser
- Weekly operation schedule
- Dual mutual standby with equal aging of gensets
- Manual "speed fine adjust" on selected ECUs
- Automatic fuel pump control
- Disable protections feature
- Excess power protection
- Reverse power protection
- Overload IDMT protection
- Load shedding, dummy load
- Multiple load management
- Current unbalance protection
- Voltage unbalance protection
- Fuel filling & fuel theft alarms
- Battery back-up real time clock
- Idle speed control
- Battery charge run enabled
- Combat mode support
- Multiple nominal conditions
- Contactor & MCB drive
- 4 quadrant genset power counters
- Mains power counters
- Fuel filling counter
- Fuel consumption counter
- Modem diagnostics display
- Configurable through USB, RS-232 and GPRS
- Free configuration program
- Allows SMS controls
- Ready for central monitoring
- Mobile genset support
- Automatic GSM geo-location
- GPS connectivity (RS232)
- Easy USB firmware upgrade
- IP65 rating with optional gasket

MEASUREMENTS

- Mains & genset PN/PP voltages
- Mains & genset frequency
- Mains & genset phase currents
- Mains & genset neutral currents
- Mains & genset, phase & total, kW, kVA, kVAR, pf
- Engine speed
- Battery voltage

FUNCTIONALITIES

- AMF unit
- ATS unit
- Remote start controller
- Manual start controller
- Engine controller
- Remote display panel

COMMUNICATION

- USB Device
- RS-232 (2400-57600baud)
- J1939-CANBUS
- Geo-locating through GSM
- GPS support (RS-232)
- Internet Central Monitoring
- SMS message sending
- E-mail sending
- Free PC software: Rainbow Plus
- Modbus RTU
- Modbus TCP/IP